

INSTALLATION INSTRUCTIONS

90DEG BENT END SIDEBARS

04-08 F-150 REGULAR CAB

PART#SSB3-F15004RCBK-WB SSB3-F15004RCS2-WB

PARTS LIST:

Qty	Description	Qty	Description
1	Driver/Left Sidebar	4	10mm Clip Nuts
1	Passenger/Right Sidebar	6	12mm x 37mm OD x 3mm Flat Washers
1	Driver/Left front Mounting Bracket	6	12mm Lock Washers
1	Passenger/Right front Mounting Bracket	6	12mm Hex Nuts
1	Driver/Left rear Mounting Bracket	4	10-1.50mm x 35mm Hex Bolts
1	Passenger/Right rear Mounting Bracket	4	10mm x 30mm OD x 2.5mm Flat Washers
4	1/2" x 2" Hex Bolts	4	10mm Lock Washers
4	1/2" x 1-1/2" x 1/8" Flat Washers	8	8-1.25mm x 30mm Hex Bolts
4	1/2" Lock Washers	16	8mm x 24mm OD x 2mm Flat Washers
2	12mm X 40mm Single Bolt Plates	8	8mm Lock Washers
2	12mm X 45mm Double Bolt Plates	8	8mm Hex Nuts
4	12mm Plastic Retainers		

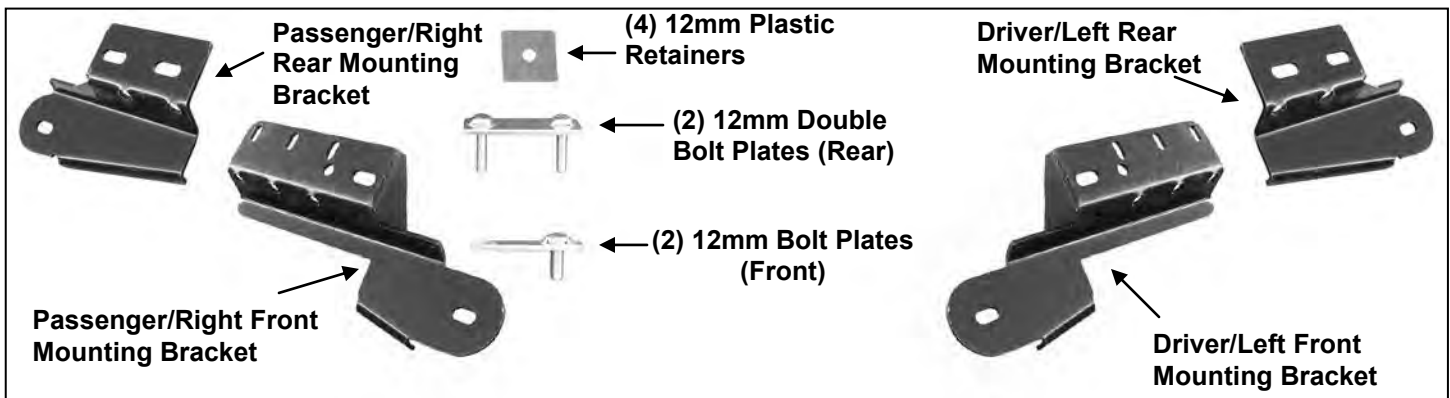

PROCEDURE:

- REMOVE CONTENTS FROM BOX. VERIFY ALL PARTS ARE PRESENT. READ INSTRUCTIONS CAREFULLY BEFORE STARTING INSTALLATION.**
- Starting at the passenger side-front of the vehicle, locate the round and rectangular openings in the inner body panel. **NOTE:** Mounting holes may be covered with rubber plugs and/or sealing tape. Remove to uncover mounting locations.
- Insert (2) 10mm Clip Nuts, (with the nut portion to the inside), into the rectangular opening. Line up the threaded nut with the factory round holes, **(Figure 1)**. Next, partially thread (1) 12mm Plastic Retainer onto (1) 12mm Bolt Plate, **(Figure 2A)**. Insert the Bolt Plate into the large round hole, **(Figure 2B)**. Once inserted, thread the Plastic Retainer onto the threaded end of the Bolt Plate until it is flush against the body panel. **NOTE:** When properly installed, the Plastic Retainer is designed to prevent the Bolt Plate from falling into the body panel during Bracket installation.
- Select the passenger side front Mounting Bracket. Attach the Mounting Bracket to the Bolt Plate with (1) 12mm Flat Washer, (1) 12mm Lock Washer and (1) 12mm Hex Nut, **(Figure 3)**. Do not tighten hardware at this time. Line up the front and center slots in the Mounting Bracket with the previously installed Clip Nuts. Attach the Bracket to the Clip Nuts with (2) 10mm Hex Bolts, (2) 10mm Lock Washers and (2) 10mm Flat Washers. Do not tighten hardware at this time.
- Next, line up the two holes in the Bracket with the factory holes in the bottom of the body panel. Bolt the Bracket to the body panel using the included (2) 8mm x 30mm Hex Bolts, (4) 8mm Flat Washers, (2) 8mm Lock Washers and (2) 8mm Hex Nuts, **(Figure 3)**. **NOTE:** Insert the Bolt with the Flat Washer up, from the outside-in and through the Bracket. Snug all hardware but do not tighten at this time.
- Moving to the rear, locate the factory large round hole and smaller oval hole in the inner body panel. **NOTE:** Remove sealing tape or plugs as necessary, **(Figure 4)**. Select (1) 12mm Double Bolt Plate.

Insert the Bolt Plate into the larger round opening and out the smaller oval hole. Next, thread (1) 12mm Plastic Retainer onto the threaded end so that the Retainer covers the smaller oval hole, **(Figure 5)**. Thread the Retainer all of the way down to the sheet metal to help hold the Bolt Plate in place.

7. Select the passenger side Rear Mounting Bracket. Attach the Bracket to the Double Bolt Plate with (2) 12mm Flat Washers, (2) 12mm Lock Washers and (2) 12mm Hex Nuts, **(Figure 6)**. Snug all hardware but do not tighten at this time.
8. Carefully unpack and select the passenger Sidebar. Position the Sidebar up to the Mounting Brackets and attach using the included (2) 1/2" x 2" Hex Bolts, (2) 1/2" Lock Washers, and (2) 1/2" Flat Washers. Snug but do not tighten at this time.

Optional Mounting Method, drilling is required: In addition to the Double Bolt Plate, the rear Mounting Bracket also has two additional slots that may be used to bolt the Bracket to the pinch weld, (similar to the front Mounting Bracket in Step 3). This step requires drilling two 3/8" holes through the pinch weld after the Mounting Bracket has been properly lined up with the Sidebar.

A. Before drilling, unpack the Passenger Sidebar and move the Mounting Brackets into the proper position in alignment with the Sidebar. Tighten the rear Mounting Bracket hardware.

B. Use the Mounting Bracket as a drill template and drill two 3/8" holes down through the open slots in the Bracket and through the pinch weld. Attach the Mounting Bracket to the pinch weld using the included (2) 8mm x 30mm Hex Head Bolts, (2) 8mm Lock Washers, (4) 8mm Flat Washers and (2) 8mm Hex Nuts. **NOTE:** Insert the Hex Bolt with the Flat Washer up from the outside-in.

This step is an option only and not required for typical installation.

9. Level and adjust Sidebar and tighten all hardware.
10. Repeat **Steps 2 – 9** for driver Sidebar installation.
11. Do periodic inspections of the installation to make sure all hardware is secure and tight.

To protect your investment, wax this product after installing. Regular waxing is recommended to add a protective layer over the finish. Do not use any type of polish or wax that may contain abrasives that could damage the finish.

For stainless steel: Aluminum polish may be used to polish small scratches and scuffs on the finish. Mild soap may be used also to clean the Sidebar.

For gloss black finishes: Mild soap may be used to clean the Sidebars.

PASSENGER SIDE INSTALLATION PICTURED

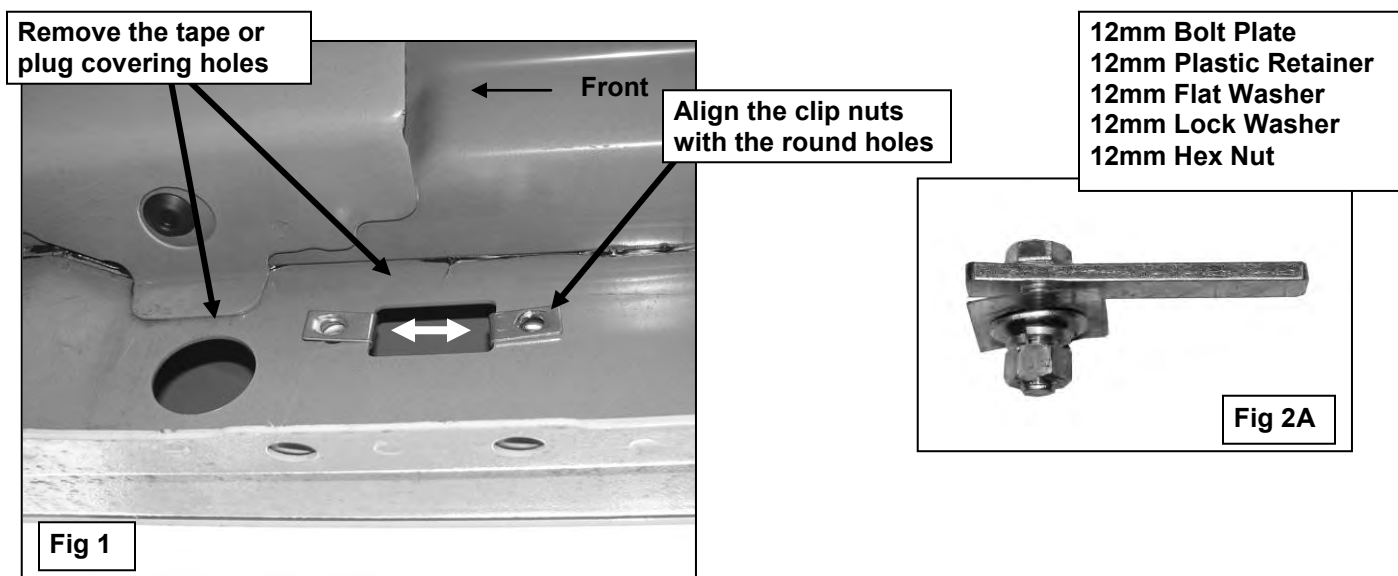

PASSENGER SIDE INSTALLATION PICTURED

12mm Bolt Plate
12mm Plastic Retainer

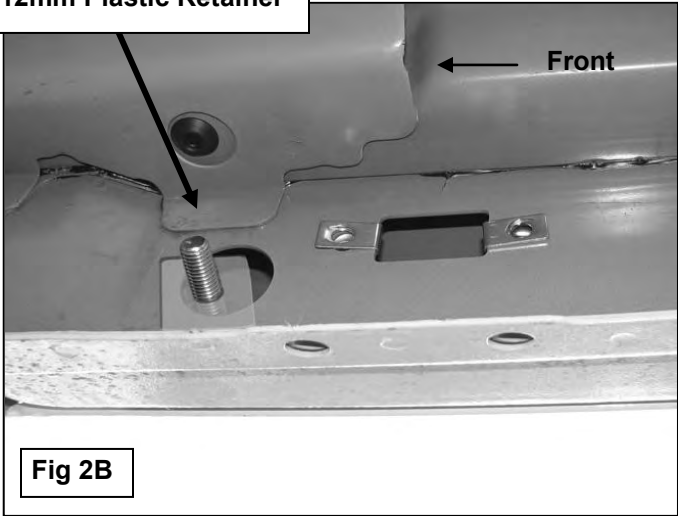

Remove sealing tape

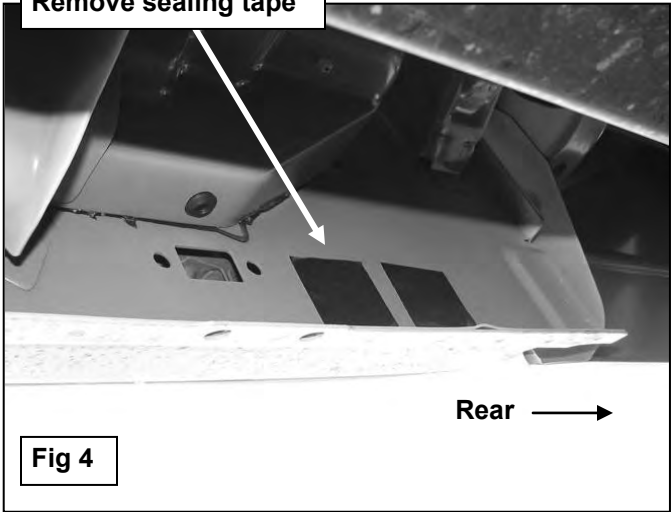

(2) 12mm Flat Washers
(2) 12mm Lock Washers
(2) 12mm Hex Nuts

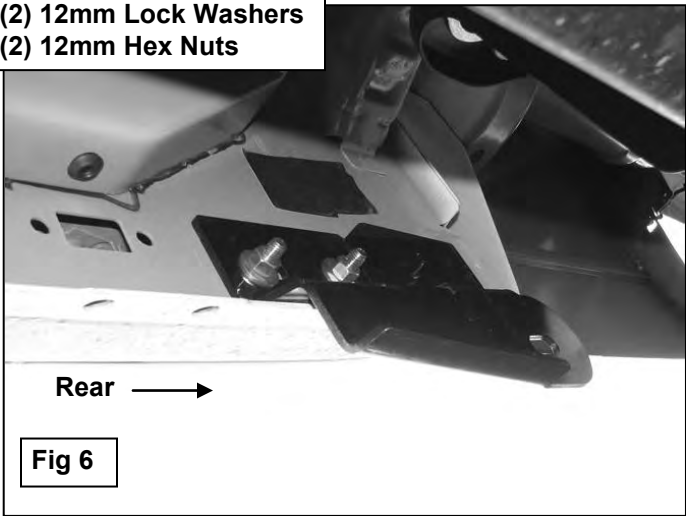

12mm Flat Washer
12mm Lock Washer
12mm Hex Nut

(2) 10mm Clip Nuts
(2) 10mm x 30mm Hex Bolts
(2) 10mm Lock Washers
(2) 10mm Flat Washers

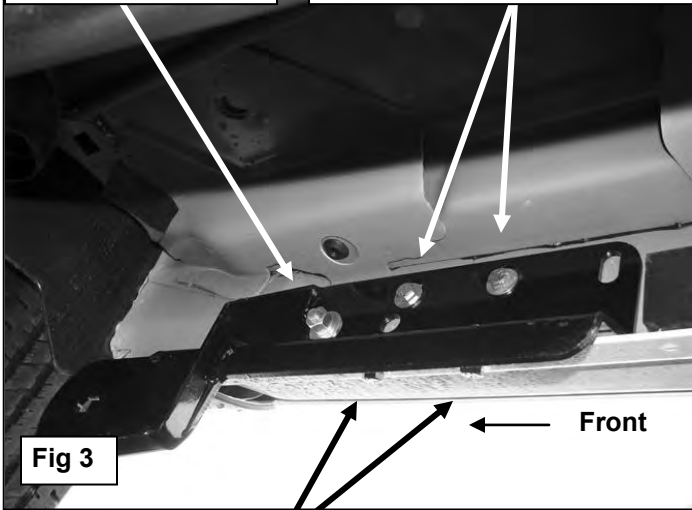

(2) 8mm x 30mm Hex Bolts
(4) 8mm Flat Washers
(2) 8mm Lock Washers
(2) 8mm Hex Nuts

12mm Double Bolt Plate
12mm Plastic Retainer

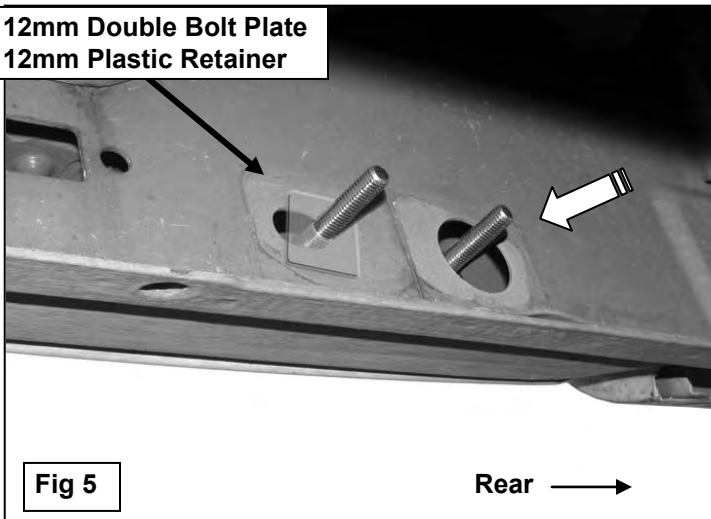

Insert Double Bolt Plate into
large factory hole and out
through smaller oval hole

PASSENGER SIDE INSTALLATION ILLUSTRATED

